

# RR301 Remote Reader

Utility Meter Remote Display

Operation and Installation Guide



## 1| Product Overview

The NextCentury RR301 Remote Reader is an advanced meter reading solution which provides a high visibility remote display of one or two utility meters. The Remote Reader is an NTEP certified remote display for water, electric, and gas applications.

The Remote Reader has an attractive consumer design, making it an ideal solution for apartment and remote metering. The utility and unit of measure are clearly displayed, ensuring an accurate interpretation of the read.

The Remote Reader utilizes **Dual Meter+™** technology, making this single model compatible with virtually all modern encoded and pulse-output utility meters, including water, electric, gas, run-time, and thermal meter models.

## 2| Technical Specifications

### 2.1 – Certifications

FCC: 20949-RR301      IC: 20949-RR301  
 NTEP: 20-012          IP-Rating: Tested to IP65

### 2.2 – Dual Meter+™

- Any combination of two encoded or pulse-output meters
- Pulse output configuration capable

### 2.3 – Configuration Requirements

- A DC301 Direct Connect device (sold separately) is required for configuration.
- Pre-programming available.

### 2.4 – Battery

- Preinstalled, field replaceable ER18505
- Up to \*10-year battery life

*\*Note: 10-year average battery life calculated and tested at typical operating temperatures between 70°F-90°F. Battery life may be reduced when operated outside of this range.*

### 2.5 – Dimensions:

- Display unit and mounting plate: 5.7" x 4.6" x 1.7" (145mm x 117mm x 44mm)
- Mounting holes center-to-center: 3.5" (88.4 mm)
- Compatible with a standard single gang wall-box

### 2.6 – Operation Environment:

- -20°C to 60°C (-4°F to 140°F)
- Should be installed in an indoor, dry environment
- Outdoor Ratings: (coming soon)

## 3| Packaging Contents

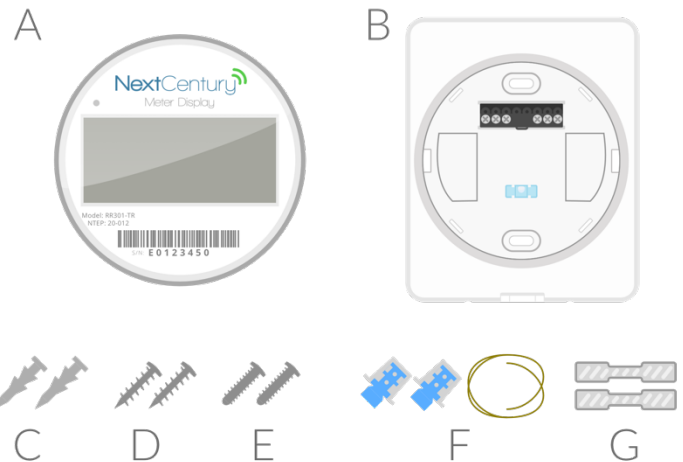

- A - RR301 Remote Reader
- B - Mounting Plate
- C - Sheetrock Anchors
- D - Wall Mount Screws #6-20
- E - Box Mount Screws #6-32
- F - Wire Security Assembly
- G - Security Seal Tabs

## 4| Meter Compatibility

The NextCentury Remote Reader integrates **Dual Meter+™** technology, allowing for compatibility with virtually all modern meter outputs.

### 4.1 – Pulse Output Meters

- Passive pulse sensing (including reed switch, solid-state relay, contact relay, open-drain types)
- Active voltage sensing (max. 16 VDC)

### 4.2 – Encoded Output Meters

- Neptune (Including ProRead, ECoder, and ProCoder register models)
- Sensus UI-1203 (Includes most meter models from Sensus, Hersey, Mueller, Master Meter, Badger, Kamstrup, Elster, Metron-Farnier, and Zenner)
- Elster/AMCO K-Frame (Includes most meter models from Elster, AMCO, ABB and Kent)

## 5| In-Field Installation

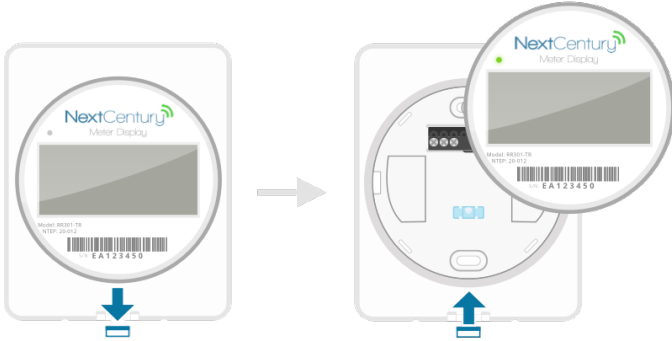

### 5.1 – Detach from Mounting Plate

- Pull down the security tab, the Remote Reader can then be pulled off the mounting plate.
- Slide the security tab back to its original position when installation is complete.

**DO NOT** open the Remote Reader unless replacement of the battery is necessary (approx. every 10 years). It is not necessary to disassemble/open a Remote Reader during installation.

### 5.2 – Install Mounting Plate

- Hold the mounting plate at the desired height and use the integrated level to straighten.
- Use a pencil to mark holes for pre-drilling
- Pre-drill using a 7/32" (5.5mm) drill bit
- Insert plastic anchors and attach the mounting plate with a PH-1 screwdriver and the two screws (fig. 3-D).

### 5.3 – Wall Box (optional)

- Pass the meter wire(s) through the mounting plate access holes
- Use a PH-1 screwdriver and the two screws (fig. 3-E) to attach the mounting plate

### 5.4 – Meter Wiring

The Remote Read can be connected to one or two meters. Use Meter 1 (left 3 terminals) and Meter 2 (right 3 terminals) to connect meters to the Remote Reader's mounting plate.

- Strip meter wire ends to 3/16" (5 mm)
- Insert the wire ends into the terminal block and tighten securely using a PH-1 screwdriver

### 5.5 – Wiring Guide

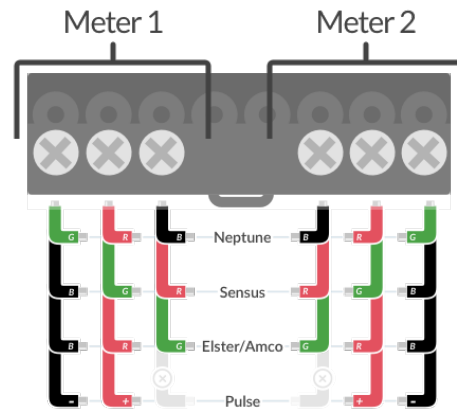

### 5.6 – Tamper Evident Seal

- The Security Tab Seal (figure 4-F) or Security Wire Seal (figure 4-G) can be used according to your installation specifications.

## 6| Configuration Programming

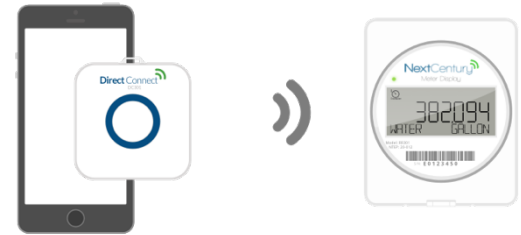

### 6.1 – Configuration Changes

- The RR301 is configured with a DC301 *Direct Connect Programmer*.
- Configuration parameters are sent using short-range wireless communication.

### 6.2 – Initiating Configuration Mode

- Configuration communication is initiated using a magnet within the magnetic activation zone.



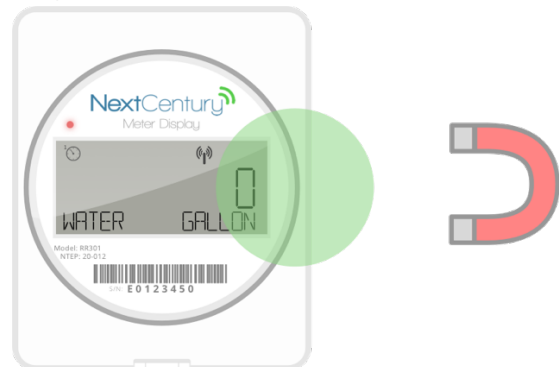

### 6.3 – Magnetic Activation Zone



Configuration wireless communication initiated when a magnet is moved past the activation zone highlighted in this figure.

### 6.4 – LED Indicator

The LED indicator provides feedback to easily check the status of the RR301.

- 8x  Config. Mode (red)
- 1x  Meter 1 Pulse (blue)
- 2x  Config. Received (green)
- 1x  Meter 2 Pulse (purple)

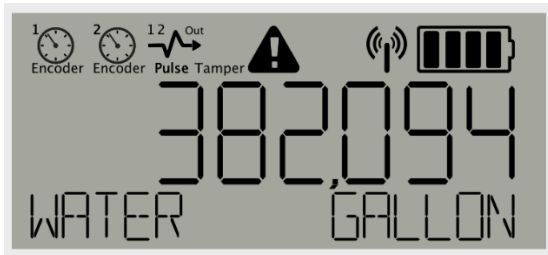

## 7 | LCD Display

### 7.1 – LCD Display Example



### 7.2 – Meter Display Views

The RR301 will rotate through the following views at a 5-10 second interval (as applicable to its configuration).

-  **Meter 1**
  - Meter read, utility, unit of measure
  - Meter read, serial number (encoded only)
-  **Meter 2**
  - Meter read, utility, unit of measure
  - Meter read, serial number (encoded only)





### 7.3 – Event Count

The RR301 maintains a lifetime count of all configuration change instances. (Example: displays as “Event 0001”.) The event count is displayed after every 5<sup>th</sup> meter view (see section 7.2).

### 7.4 – Alerts

The Remote Reader displays an icon for active alerts. Freeze, leak, and low battery alerts are cleared automatically when the alert condition is no longer true.

Tamper alerts must be cleared manually using the Direct Connect (see section 6).

 Tamper	<b>Tamper</b> RR301-TR removed from wall. Alert initial 30-minute hold-off for installation. <i>Icon will remain until dismissed.</i>
 Freeze*	<b>Freeze*</b> Ambient temperature is currently below 36°F (2°C).
 Leak*	<b>Leak*</b> Meter read has incremented every 2 hours for 24-hour period.
 Low Batt.	<b>Low Batt.</b> Replace Battery (4-6 months remaining).

**\*Note:** Freeze and Leak Alerts are only displayed when configured for a water utility. (All Water, Cold Water, Hot Water, Commercial Water.)

### 7.5 – Utility Types

The configured utility type is shown on the bottom left of the display.

- All Water
- Cold Water
- Hot Water
- Commercial Water
- Gas
- Electric
- Run-Time

### 7.6 – Units of Measure

The configured unit of measure is shown on the bottom right of the display.

- Gallons (water)
- Liters (water)
- Cubic Feet (water, gas)
- Cubic Yards (water, gas)
- Cubic Meters (water, gas)
- Kilowatt Hour (electric)
- Watt Hour (electric)
- Hours (run-time)
- Minutes (run-time)
- Seconds (run-time)

## 8| Television and Radio Interference

This equipment has been tested and found to comply with the limits for a Class B digital device, pursuant to Part 15 of the FCC Rules. These limits are designed to provide reasonable protection against harmful interference in a residential installation. This equipment generates, uses and can radiate radio frequency energy and, if not installed and used in accordance with the instructions, may cause harmful interference to radio communications. However, there is no guarantee that interference will not occur in a particular installation.

If this equipment does cause harmful interference to radio or television reception, which can be determined by interference to radio or television reception, which can be determined by turning the equipment off and on, the user is encouraged to try to correct the interference by one or more of the following measures:

- Reorient or relocate the receiving antenna.
- Increase the separation between the equipment and receiver.
- Connect the equipment into an outlet on a circuit different from that to which the receiver is connected.
- Consult the dealer or an experienced radio/TV technician for help.

## 9| FCC Part 15 and Industry Canada Compliance

This device complies with part 15 of the FCC Rules and Industry Canada license-exempt RSS standard(s). Operation is subject to the following two conditions: (1) this device may not cause interference, and (2) this device must accept any interference, including interference that may cause undesired operation of the device.

This portable equipment with its antenna complies with FCC's and IC's RF radiation exposure limits set forth for an uncontrolled environment. Users are advised to maintain a separation distance of 20cm to comply with FCC and IC RF exposure limits.

Le présent appareil est conforme aux CNR d'Industrie Canada applicables aux appareils radio exempts de licence. L'exploitation est

autorisée aux deux conditions suivantes : (1) l'appareil ne doit pas produire de brouillage, et (2) l'utilisateur de l'appareil doit accepter

tout brouillage radioélectrique subi, même si le brouillage est susceptible d'en compromettre le fonctionnement.

## 10| Warranty/Disclaimer Scope of Warranty

NextCentury warrants that all communication equipment manufactured by NextCentury will be free from defects in materials and workmanship under normal use and in accordance with NextCentury's documented installation and operating procedures for a period of three (3) years from the date of manufacture.

Products not manufactured by NextCentury, including without limitation, accessories, attachments, meters, or batteries used in conjunction with NextCentury equipment are warranted, if at all, only by the original manufacturer. NextCentury's warranties do not include replacement of batteries used to power NextCentury products.

### Limits of Liability

This warranty only applies to Read Management System components produced by NextCentury, and does not cover any products which have been damaged by misconduct, negligence, vandalism, acts of God, excessive operating conditions, or unauthorized attachments or modifications. This warranty will be null and void if products are placed in non-recommended installation application/fashion, or are converted, altered, or treated by other than NextCentury recommended procedures and instructions, or are read by equipment not approved by NextCentury.

NextCentury's liability and customer's exclusive remedy under this warranty is expressly limited to repair or replacement of the product at

NextCentury's option, and is conditioned upon the customer returning the product(s) to the location designated by NextCentury within the warranty periods or limits stated herein, and pre-paying the freight costs both to and from specified location. In no event shall NextCentury be liable for costs or expenses associated with the removal or installation of products under this warranty.

NextCentury shall have no liability or responsibility to the purchaser or any third party for any loss, cost, expense, damage, or liability, whether direct or indirect, or for special, incidental, indirect, or consequential damages of any kind, regardless of whether such liability is based on breach of contract, tort, strict liability, breach of warranties, or otherwise, and even if advised of the likelihood of such damages. Incidental and consequential damages include, but are not limited to, lost revenue, loss of profits, data, business, or goodwill. In addition, damages resulting from negligence on the part of the customer, including, but not limited to, the care and maintenance of NextCentury products or damages resulting from negligence regarding periodic testing of the product's performance, are not covered under this guarantee.

CHANGES OR MODIFICATIONS NOT EXPRESSLY APPROVED BY NEXTCENTURY MAY VOID THIS WARRANTY AND THE USER'S AUTHORITY TO OPERATE THE EQUIPMENT.

THE FOREGOING WARRANTY IS THE SOLE AND EXCLUSIVE REMEDY AVAILABLE TO THE PURCHASER AND IS IN LIEU OF ALL OTHER WARRANTIES, GUARANTEES, OR REMEDIES, WHETHER WRITTEN OR ORAL, EXPRESS OR IMPLIED, INCLUDING WITHOUT LIMITATION, THE IMPLIED WARRANTIES OF MERCHANTABILITY AND FITNESS FOR A PARTICULAR PURPOSE, ALL OF WHICH NEXTCENTURY HEREBY EXPRESSLY DISCLAIMS.

---

## 11| Contact Information

For any questions or concerns, please contact NextCentury Submetering Solutions Product Support:

- Phone: (844) 538.8203
- Email: [support@nextcenturymeters.com](mailto:support@nextcenturymeters.com)